

# Power-line Communication Channel Characterization and Modeling for Transportation Systems

Pierre Degauque, Igor S. Stievano, Sergio A. Pignari, Virginie Degardin, Flavio Canavero, Flavia Grassi, and Francisco J. Cañete

*This paper provides an overview of the recent advances in the characterization and modeling of power line communication channels in transportation systems. The salient aspects of the topological and functional features of the data channels using power networks of vehicles, spacecrafts and aircrafts are presented. The contribution has a tutorial nature and guides the reader through a selection of recent papers collecting relevant results needed to assess the feasibility and strengths of power line communication for this class of applications.*

## I. Introduction

Possible applications of power line communication (PLC) in transportation systems, mainly in vehicles (cars), aircrafts (A/C), or spacecrafts (S/C), are currently under investigation [1], [2]. Indeed, the ever-growing amount of in-vehicle electronic equipment requires a large number of wires for data transfer, unavoidably leading not only to a rise of mass and weight, but also increasing wiring harness complexity and thus impacting reliability and maintenance cost. This issue is particularly acute in the aeronautical domain and an elegant solution might be PLC implementation. However, it is not possible to directly transpose widely published results obtained for low voltage power lines or in-house PLC [3] to transportation systems because the geometrical characteristics and tree-shaped topologies of the cable bundles are completely different. For assessing strengths and limitations of the PLC technology, a simulation tool with an effective channel model is needed.

For communication between two PLC modems, the channel can be considered as a “black box” characterized in the time or frequency domain. The channel transfer function  $H(f)$  is either estimated from measurements or deduced from appropriate channel models, considering the harness as a cascade of interconnected transmission lines. However, its exact geometrical configuration and the impedances of its loads are random variables. Furthermore,  $H(f)$  strongly depends on the location of the coupling points of the modems to the power line and, consequently, channel modeling must include statistical aspects. In addition, due to the multiple reflections caused by the impedance mismatch at the cable terminations and branching, PLC channels can be considered as frequency

selective channels. This feature leads to the typical behavior exhibited by the classical radio channels that have been deeply studied in literature, from both a measurement and a modeling point of view (e.g., see [4], [5] and the other contributions of this special issue). Hence, in this paper, the PLC channel modeling is presented with specific emphasis on the features of signal propagation along a wired network.

Another major issue of PLC is to ensure the electromagnetic compatibility (EMC) with the environment. Firstly, the susceptibility of the communication to disturbing noise, often of impulsive nature, must remain within acceptable limits. Noise characterization and modeling have thus to be included in the channel model. Secondly, the PLC line must not disturb the environment, and the upper limits of conducted/radiated emissions given by the standards are, by far, much more critical in S/C – A/C [6], [7] than for in-vehicle applications [8]. In a vehicle, a wire-to-chassis excitation is quite common. However, if such a common mode (CM) transmission is implemented in S/C or A/C, the conducted emission and susceptibility levels will not fulfill the aeronautical EMC standards. In this case, a balanced signaling scheme on a twisted pair (TWP) power bus can be used, but its performance depends on the differential mode (DM) to CM conversion. This conversion phenomenon has already been well investigated [9], [10]. It is due to the unbalance introduced by the coupling of the TWP to all other wires inside the harness, and by the terminal equipment. DM-to-CM conversion is also addressed by several standards for telecommunications cables, as in [11], where conversion loss parameters such as longitudinal and transverse conversion losses are introduced to quantify the degree of imbalance above ground affecting the wiring structure and terminal networks.

Channel modeling based either on measurements or on a network physical structure analysis allows an estimation of the signal-to-noise ratio (SNR) expected at the receiving modem. In the examples presented throughout this paper, the PLC frequency band extends from about 2 MHz to 30 MHz, with a possible extension up to 100 MHz, depending both on path loss and EMC constraints.

The paper is organized as follows. First, the propagation characteristics and channel modeling for in-vehicle (automotive) application, exploiting either a frequency- and

time-domain “black box” approach or the transmission line theory, are presented. PLC for avionics applications, mainly for S/C and A/C, are then described, with a special emphasis on the modeling of differential signaling and on the DM to CM rejection ratio.

## II. In-vehicle channel modeling

This section summarizes the main topological features and channel characteristics of the power networks used within a vehicle. Specific emphasis is first given to the discussion of the typical harness topology and to the characteristics of the measured channel transfer functions. Then a black-box parametric channel representation based on a tapped-delay line model and a transmission line model are successively described.

### II.1 Harness Topology

Electronics in vehicle may represent up to 30% of vehicle cost and one can expect that this percentage may reach 40-50% in the future [12]. Indeed, to ensure the safety and the comfort of the driver and passengers, both safety systems (e.g., antilock braking system, parking sensors, traction control system, driver alertness detection system, etc.) and numerous multimedia systems are implemented in the car. Data communication between the 80-100 Electronic Control Units (ECU) distributed in the car and the sensors and actuators are now ensured through standardized protocols such as controller area network (CAN), local internet network (LIN), media-oriented system transport (MOST), FlexRay and Ethernet [13], TWP cables often being used for transmitting the safety-related signals. On average, the total length of all wires inside a car is about 2500 m.

A schematic view of part of a network between the engine compartment and the passenger cell, defined in collaboration with a car manufacturer, is shown in Fig. 1 [14]. Two types of links are envisaged: either between terminals equipments D1 and D2 or between D3 and D4.

The nodes of the network are defined as the points where two or more branches are connected, or where there are lumped loads, normally at the line terminations (terminal nodes). A branch is thus a single path which connects one node to another. Each branch is physically composed of wire harness sections, containing power supply lines, single wires or TWP that transmit either digital or analog signals, and ground wires. In this example, the tree network includes 53 branches, each branch contains between 1 and 30 wires and 21 of the 60 nodes are terminal nodes connected to 116 loads.

If we consider a PLC between two modems, each one being connected between the dc power wire and the chassis (CM transmission), two types of links are envisaged. A link is labeled either “direct link” if the shortest path between the modems does not pass through the battery, as D3-D4 in Fig. 1, or “indirect link” in all other cases (D1-D2). This distinction is based on the fact that the battery presents very low impedance

in the PLC frequency band, and thus leads to a strong increase in path loss.

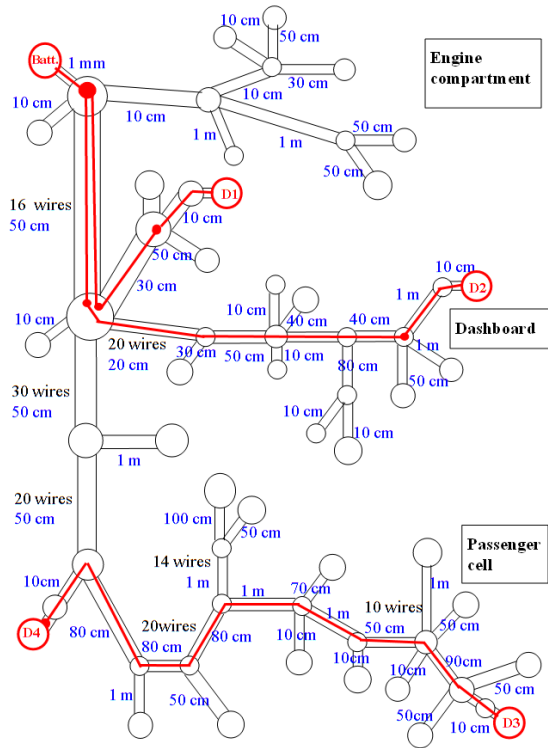

Figure 1. Topology of part of a representative network of a vehicle. The two red lines D3-D4 and D1-D2 correspond to a “direct” path and to an “indirect path”, respectively. The lengths of the branches and the number of wires in some branches are also indicated [14].

A statistical analysis of the channel properties, needed to build a model, is made by collecting a set of scattering parameters between different probing points of the power network and by considering different states of the vehicle: engine turned on or off, electronic functions activated or not. Similarly, in the channel model based on the multiconductor transmission line theory (MTL), loads can be considered as random variables to represent the a priori unknown values of their impedance.

### II.2 Channel Characteristics and Measurements

The recent interest in the application of PLC technology to in-vehicle power networks drove the attention of designers and researchers toward the experimental characterization of actual channels and to provide modeling and design solutions. In the literature, there are papers with specific emphasis on systematic measurement campaigns. Frequency-domain channel transfer functions are in general defined by their  $S_{21}$  transmission scattering parameter, or insertion gain, obtained via a Vector Network Analyzer (VNA). Two-port measurements are carried out between pairs of access points located along the power line [14] – [17].

The common features of these transfer functions can be clearly appreciated by the set of responses in Fig. 2. They correspond to a number of PLC links on the power distribution system of a compact economy car with different operating conditions, such as the engine or the lights turned on/off. The above measurements exhibit a rich dynamical behavior with rolling maxima and deeps, thus confirming the expected frequency-domain responses of multi-branch wiring structures presented in the previous section. Such variations of the transfer function are of course a characteristic of a frequency selective fading channel. Also, the wide amplitudes displayed in Fig. 2 emphasize the large variability of the channel attenuation, depending on the links and on the operating states of the car. This behavior is in agreement with [14], [16], where the responses are classified in terms of direct and indirect connections. It is also worth noticing that, if the operating condition of the car does not introduce channel discontinuities, the signature of the frequency-domain response of a given link does not exhibit large changes, as highlighted by the black curves in Fig. 2.

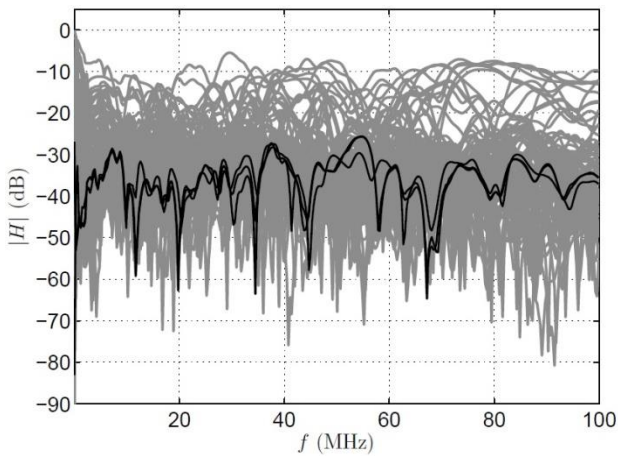

Figure 2. Magnitude of the channel transfer function, which is related to scattering parameters of the test vehicle of [15]. The gray curves belong to the complete set of 106 measurements corresponding to different links and/or possible operating states of the car. The black thick lines are the measurements associated with the link between the front left headlight and the power-supply connector of the car-radio, for three operating states (see [15] for details).

In order to provide designers with a more compact representation of the PLC channel characteristics, a statistical assessment of the measured responses is needed and suitable indices or metrics are derived. Probability density functions or cumulative distributions of some representative parameters such as the mean attenuation or the coherence bandwidth are computed (e.g., see [14], [16], [18]). As an example, Fig. 3 shows the cumulative distribution of the insertion gain (IG), i.e., the average magnitude of the transfer function in the frequency range of interest, computed from the two separate sets of direct and indirect in-vehicle measured links. Curves in Fig. 3 were deduced from 150 channel transfer functions (1-30

MHz) and successively measured in two vehicles between a point near an onboard computer and three other points in the vehicle (direct or indirect links). Fig. 3 provides an immediate visual synthesis of the expected behavior of the channel under investigation for the group of access points considered in the study. Furthermore, according to [14]-[16], the coherence bandwidth is between 500 kHz and 1.5 MHz, and the rms delay spread is between 100 and 200 ns.

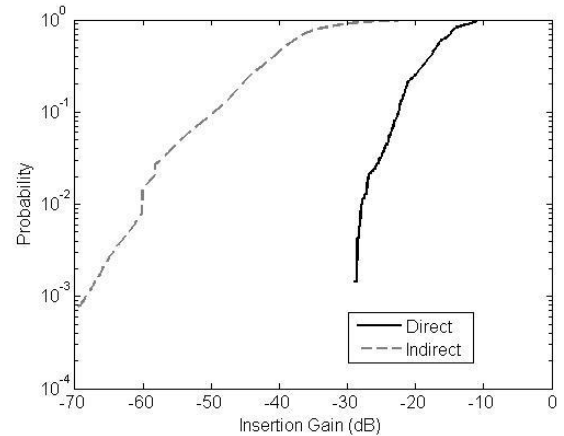

Figure 3. Cumulative distribution function of the average insertion gain obtained from the experimental data of [14].

Another important quantity that provides useful information on the PLC channel characteristics is the frequency variation of its input impedances. According to [14] and [16], the input impedance is characterized by a remarkable frequency selectivity as observed in the transfer functions of Fig. 2 and values in the range from few to one thousand Ohms. The above results are in agreement with other contributions in the literature (e.g. see [19], where the analysis is carried out in a frequency band up to 100 MHz).

It is important to notice that the above channel responses represent the functional behavior of the power network only. However, due to the activity of the various electrical (possibly switching) equipment connected to the power line, the effects of time-domain disturbances flowing through the PLC channel cannot be neglected and should be taken into account. They are seen as additive noisy signals that unavoidably perturb the data communication and that play a dominant role in the assessment of the robustness of a PLC implementation. The noise is classified into separate contributions with spectral characteristics that strongly depend on the specific power system onto which the PLC technology is intended to be used. The typical examples are the short-lasting high energy impulsive disturbances arising from the injection system in cars or the dc/dc converter noise in the alternate S/C application that are in general complemented by a superimposed background colored noise. The main criteria for pulses classification are their waveform, amplitude, frequency content, power, mean duration and lastly, interarrival time, i.e. the time interval between two successive pulses. The characteristics of the

impulsive noise are quite different for in-house and in-vehicle networks. A statistical analysis applied to measurement results have shown that pulse amplitude and pulse duration are much greater on the indoor network but the interarrival time is higher in vehicle [20]. For additional details, papers devoted to noise characterization and modeling [21] - [23] are available.

### II.3 Measurement-Based Channel Model

The classical solutions for the black-box modeling of the functional behavior of a PLC channel rely on the so-called tapped delay line (or multipath) parametric model representation [24]-[26]. For any point-to-point communication, it describes the received signal in terms of a finite sum of delayed and possibly corrupted replicas of the transmitted signal. The rationale of the above choice arises from the inherent features of the propagation of signals along a possibly complex interconnected structure of multiconductor power lines [15]. The model in the frequency-domain writes:

$$H(j\omega) \cong \sum_{k=1}^m g_k \exp(-j\omega\tau_k) \quad (1)$$

where H is the transfer function of interest (e.g., each individual curve of Fig. 2). The unknown parameters are the  $m$  linear complex coefficients  $g_k$  and the  $m$  time delays  $\tau_k$  (exponential terms in the model equation), that account for the attenuation and phase distortion of the transmitted signal. As already done for the case of in-home PLC channels, equation (1) can be possibly improved by including additional frequency-dependent weights that account for the cable losses. However, for the specific application at hand, and for the frequency range of interest (up to 100 MHz), this modification is not required and the lossless relation (1) has been proven to provide accurate results. Additional details of this structure and of the systematic assessment of model performance based on both simulation results and real measurements are available in [15] and references therein.

Based on the flexible representation in (1), model parameters can be computed from time- or frequency domain responses of the PLC channel. As an example, the impulse response of Fig. 4, obtained via the inverse fast Fourier transform (IFFT) of the original frequency-domain data, can be used to locate the position of the peaks described by the exponential terms in (1).

Hence, the dominant  $m$  delays and the weighting coefficients can be selected directly from the above impulse response or computed via the solution of a least square fitting problem applied to the frequency-domain transfer function. This choice leads to a robust procedure providing models with a tunable accuracy and that mimic the behavior of actual in-vehicle channels. As an example, the curves in Fig. 5 show that a typical measured response can be reproduced with a model defined by 56 delay terms; in this case, the accuracy is quantified by a relative mean square error of 1%.

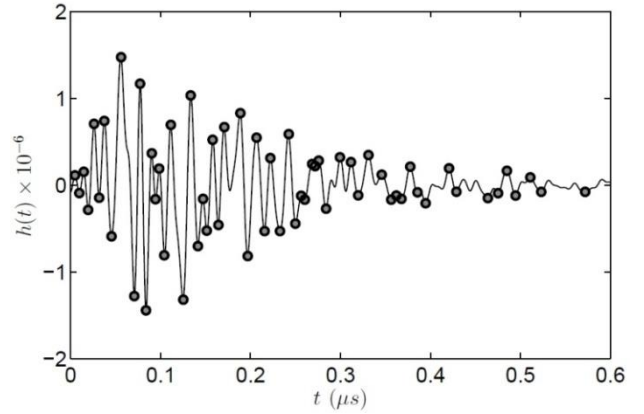

Figure 4. Example of a channel impulse response  $h(t)$  (solid lines) and selected peaks (circles) that correspond to the delays of (1) [15].

A smaller number of delays, in the range 5 to 20, may be used if an accuracy of 10% is acceptable. A simple parametric relation with a small number of parameters reduces the complexity of the hardware implementation of a PLC channel emulator, thus enabling fast data processing and a simpler design solution.

It is relevant to remark that the black-box approach presented in this section generates surrogate models describing the transmission of signals between pairs of points along the PLC network. To reproduce the large variability of responses occurring in reality, a statistical model can be devised, with model parameters defined in terms of random variables with suitable distributions (e.g., see [15], [18]). Without claiming an in-depth review of the state-of-the-art contributions of statistical models, we point out to [17], [26] as complementary and alternative papers on this subject.

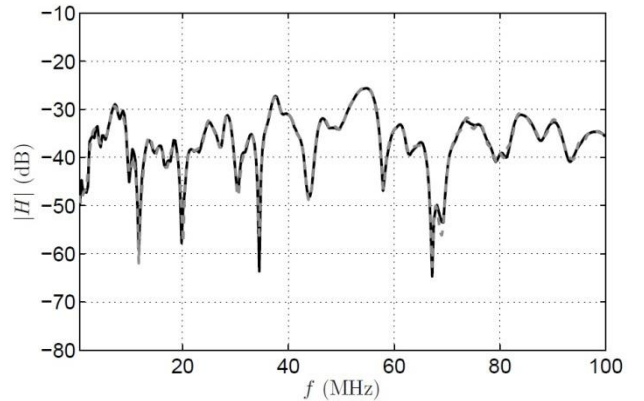

Figure 5. Example of transfer function [15]. Solid black: measurement; dashed gray: response of a model with  $m = 56$  delays.

### II.4 Transmission Line Model

As shown in Fig. 1, the power wires are often part of a large bundle, where the other wires influence, by crosstalk, the propagation characteristics of the line carrying PLC signals.

The basic approach for predicting the channel transfer function relies on the MTL theory [27], applied to all branches of the entire network. Nevertheless, simplifications in the network topology are introduced in order to decrease the computational time. Firstly, the harness is divided into a succession of uniform transmission lines. For an in-vehicle application, this corresponds to the branches shown in Fig. 1, the wires being assumed to be parallel to a ground plane and coated with a dielectric sheath. Because analytical formulas are not available for non-homogeneous configurations, the per unit length parameters are deduced from the numerical solution of the Laplace equation in the cross section plane of a branch. Even if the basic equations of the MTL are straightforward, a highly flexible approach must be employed to easily modify the network architecture. As an example, the so-called “topological approach” introduced some ten years ago in the EMC domain, but only recently applied to communication networks [14], is based on the concept of waves  $\mathbf{W}(z)$ , relating currents and voltages and widely used in the microwave circuits domain.  $\mathbf{W}(z)$  is defined by:

$$\mathbf{W}(z) = \mathbf{V}(z) + \mathbf{Z}_c \mathbf{I}(z) \quad (2)$$

where  $\mathbf{V}(z)$  and  $\mathbf{I}(z)$  are the vectors of the voltages and currents along a tube of  $N$  wires,  $\mathbf{Z}_c$  being the characteristic impedance matrix. Each branch is also characterized by its propagation matrix  $\boldsymbol{\gamma}$ , while a scattering matrix  $\mathbf{S}$  is defined at each node.  $\mathbf{S}$  is either deduced from the architecture of the node, or from measurement data if the nodes are of high complexity. By introducing the boundary equations at each node, the wave vector  $[\mathbf{W}(\mathbf{0})]$  at the origin of each branch is the solution of a linear equation involving global scattering  $[\mathbf{S}]$  and propagation  $[\boldsymbol{\gamma}]$  matrices as follows:

$$([\mathbf{I}] - [\mathbf{S}][\boldsymbol{\gamma}])[\mathbf{W}(\mathbf{0})] = [\mathbf{S}][\mathbf{W}_s] \quad (3)$$

where  $[\mathbf{I}]$  is the identity matrix with a rank equal to the total number of unknowns on the network (e.g., two times the number of wires in each tube). The non zero elements of  $[\mathbf{W}_s]$  are the source terms. Since  $[\mathbf{S}]$  and  $[\boldsymbol{\gamma}]$  are partitioned by blocks, each of them corresponding to one branch or one node, modifications in part of the network topology are easily introduced in the model [14].

The transfer functions  $H(f)$  between the source and any receiver are easily deduced from  $[\mathbf{W}(\mathbf{0})]$ . Lastly, calculating  $H(f)$  between one receiving point and various positions of the source is straightforward, the computational time being only related to the inversion of the matrix term on the left hand side of (3).

Such a model can be improved to take into account possible changes either of the relative position of the wires along a branch or of their height above the ground plane. In this case, each MTL branch is subdivided into a series-cascade of uniform MTL sections and, as proposed in [28], the network

under study can then be transformed in a lumped circuit network to be easily analyzed by commercial circuit simulator.

For a given network architecture, the statistical behavior of the channel is usually carried out through a Monte Carlo approach, by randomly choosing the load impedances. Examples can be found in [14] for in-vehicle applications, while a comparison between predicted and measured values of the channel transfer functions is given in a next section for an avionics network.

Nevertheless, if available, the frequency-dependence of the impedance of a few loads deduced from measurements can also be introduced in the model [28]. Since feasibility of PLC must be assessed for a class of vehicle, and not only for a specific one, various realizations of network topology are carried out. The different architectures of such networks are defined by the car manufacturers. In the future, one can imagine collecting enough information on the variability of the topology to follow an approach proposed in [29] for in-house power lines to build a random topology model.

### III. Avionics channel modeling

#### III.1 Spacecraft

On spacecrafts, the electric power is delivered to payloads and sensors via differential dc power buses, implemented as TWPs running above ground. For instance, in a typical satellite architecture, both the power-supply network and the data-handling system exhibit star topology, with the power control and distribution unit (PCDU) and the onboard computer (OBC) being the star-centers [2]. These characteristics make the integration of power and data by the PLC technology attractive for a twofold reason. First, network architecture inherently excludes multiple propagation paths, typical in networks with tree-shaped topology, e.g., the in-vehicle and A/C power lines. Second, the twisted-wire structure of the buses offers privileged communication channels supporting DM signaling.

From the EMC standpoint, spinning the PLC technology in the space sector requires to verify that radiation from the PLC system does not cause interference in other electronic devices and sensitive payloads, and transmission performance is not degraded by conducted noise generated by the dc/dc converters inside the power units. Here, the key theoretical concept to assess transmission and immunity properties of the PLC channels is modal decomposition and characterization of mode-conversion resulting from system imbalance (mainly due to the non-ideal behavior of the terminal units) [23], [30].

For a three-conductor system, modal analysis is based on the decomposition of the physical currents  $I_1, I_2$ , and voltages  $V_1, V_2$  into auxiliary CM ( $I^{CM}, V^{CM}$ ) and DM ( $I^{DM}, V^{DM}$ ) variables. Fig. 6 illustrates the block diagram of a possible implementation where the PLC modems are parallel-connected to the dc bus by means of capacitors, whereas series inductors are used to decouple the power units from the signal path.

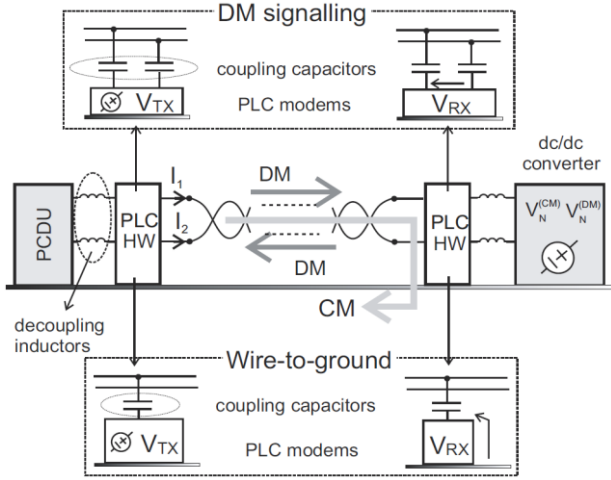

Figure 6. Schematic diagram of a PLC link on a S/C power bus with DM signaling or wire-to-ground transmission.

For modeling purposes, MTL theory [27] is used for the power line, whereas Thevenin equivalent circuits suitably extracted from measurements are used to model the power units (PCDU and dc/dc converter). The voltage across the receiving modem is the superposition of two contributions, i.e.  $V_{RX} = V_{RX}^S + V_{RX}^N$ . The first,  $V_{RX}^S = H_S(f)V_{TX}$  represents the received signal in terms of the channel transfer function  $H_S(f)$ . The second, written as,

$$V_{RX}^N = H_N^{(DM)}(f)V_N^{(DM)} + H_N^{(CM)}(f)V_N^{(CM)} \quad (4)$$

expresses the received noise in terms of the modal components  $V_N^{(DM)}$ ,  $V_N^{(CM)}$  of the noise generated by the dc/dc converter (rightmost block) through the transfer functions  $H_N^{(DM)}(f)$ ,  $H_N^{(CM)}(f)$ , [23]. The ratio  $V_{RX}^S/V_{RX}^N$  represents the SNR of the PLC link.

As an example, Fig. 7 illustrates the predicted increase  $\Delta$  of the SNR of a real PLC link involving DM signaling (i.e., balanced signaling) rather than wire-to-ground transmission. It is worth noting that the amount of increase is tightly related to the frequency behavior of the terminal units, which were modeled starting from the theoretical and experimental results described in [23]. Particularly, the SNR of the balanced transmission scheme results to be larger for the two following reasons. Balanced signaling yields a theoretically flat channel frequency response, whereas wire-to-ground transmission is affected by in-band notches (due to the coexistence of DM and CM, and resonances with the coupling/decoupling networks). Balanced signaling also offers larger immunity to power-line noise. As a matter of fact, since the dc/dc converters CM noise is dominant in the frequency range of interest for PLC, conducted susceptibility mainly depends on balancing characteristics of the whole PLC link (including modems and power units) [10]. Even if the power units typically show imbalance, differential signaling takes advantage from the circuit configuration to increase the ability of the

transmitting/receiving modems in rejecting the CM noise. Conversely, in case of wire-to-ground signaling, mode conversion is further increased by the specific connection topology of the modems.

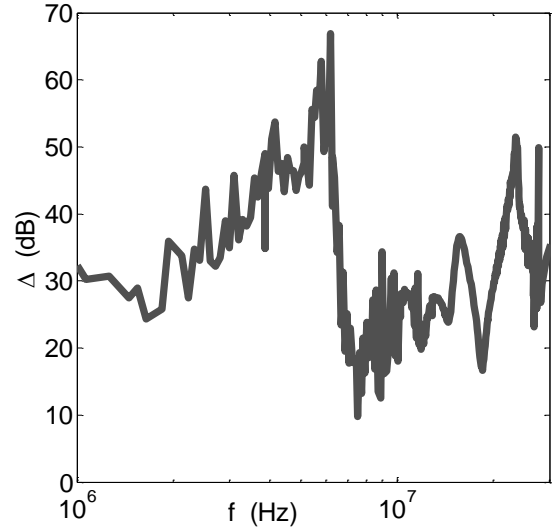

Figure 7. Predicted increase (in decibels) of the SNR for a PLC system using DM signalling rather than wire-to-ground transmission.

In conclusion, description of signal and noise propagation along the PLC link in terms of the modal variables has the potential to provide deeper physical insight and can be used to optimize transmission performance and EMC characteristics. Particularly, when applied to a PLC link on a power bus for S/C, modal analysis offers a straightforward way to prove the superiority of differential signaling in terms of transmission properties and immunity to conducted noise.

### III.2 Aircraft

One possible application of PLC inside an A/C is the cabin lighting system (CLS). The actual CLS of a commercial aircraft is a cellular approach, each cell consisting of a secondary power distribution box (SPDB), feeds up to 14 illumination ballast units (IBU). Each IBU includes an illumination system, attendant work lights, reading lights and area call panel. The IBUs are remotely controlled by the cabin crew through dedicated wires which can be replaced by a PLC link. A representative CLS tree shaped architecture shown in Fig. 8, leads to a network of 38 branches [31], [32].

The number of wires inside the cable bundle of each branch varies from 2 to 30, the total length of the wires being 750 m, while the maximum length between the SPDB and the farthest IBU is 43 m [32]. Such a configuration being similar to an in-vehicle architecture and not presenting a star-topology, multipath propagation will occur. Theoretical analysis, based on MTL [27], has shown that the EMC standards [6], [7] cannot be fulfilled with a CM excitation, and a balanced

signaling scheme on a TWP power bus must be used, as in S/C. Indeed, let us recall that the DO160 aeronautic standard [6] put limits on the maximum value of the CM noise current spectral density which must remain below  $20 \text{ dB}\mu\text{A}/\text{kHz}$  in the PLC frequency band. For the time being, there is no spectral mask defined in this standard.

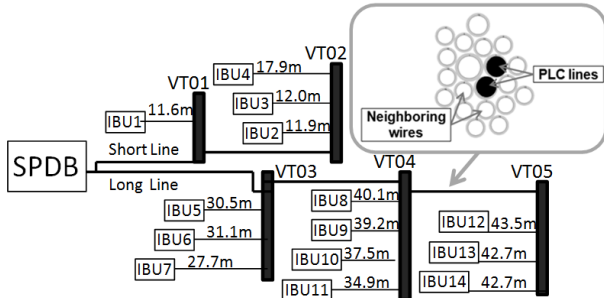

Figure 8. Schematic diagram of the harness representative of a cell of the lighting system in an aircraft cabin. The distance between each IBU and the SPDB is indicated and VTs refer to multiplying connectors [31].

Taking the complexity of the real structure into account, the transfer function between the SPDB and each of the 14 IBUs, numbered 1 to 14, was deduced from the MTL model but assuming a non twisted pair (NTWP). The cumulative distribution function (cdf) of the insertion gain in the 1-30 MHz band is plotted in Fig. 9 for the links SPDB - IBUs 4, 9 and 14, situated at 18, 39 and 43 m, respectively. The dotted curve refers to values of the insertion gain deduced from the MTL model and calculated over all frequency points in the 1-30 MHz band, while the continuous curves correspond to measured values.

For a probability of 0.5, insertion gains, measured or deduced from the channel model, are in good agreement. However, the predicted low values of IG occurring with a low probability for the links to IBU 9 and 14 are not experimentally observed. This can be explained by the inherent difficulty in simulating a complex geometrical structure, but also by the assumption of an NTWP. For a magnitude of the complex correlation function of 0.9, the minimum value of the coherence bandwidth is 0.9 MHz and the maximum delay spread is 0.1  $\mu\text{s}$ .

Such a “simplified” model is not able to predict the DM – CM modal conversion but knowledge of this is of prime importance. Indeed, as previously outlined, EMC aeronautic standards give the upper limit of the signal, not in terms of transmitting power but in terms of the induced CM current  $I^{(CM)}$  flowing on all wires of the cable bundle. Therefore, the common mode rejection ratio (CMRR), defined by the ratio of  $I^{(CM)}$  to the injected DM current must be measured. To achieve this goal, a generator was connected at one end of the PLC twisted pair, the DM current and CM current being measured at a distance of 5 cm from the injection point of the current.

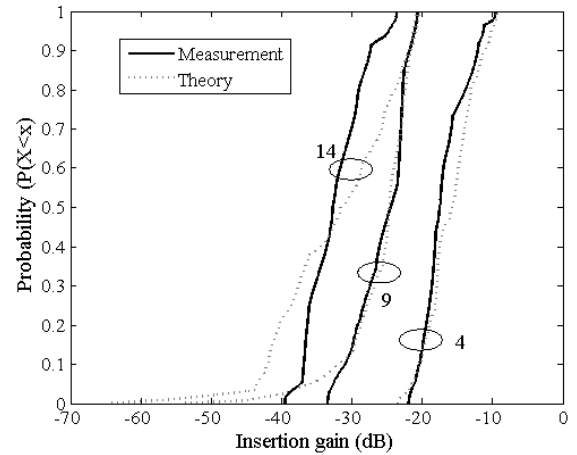

Figure 9. Cumulative distribution function of the predicted or measured insertion gain and for 3 links between the SPDB and the IBUs 4, 9 and 14, situated at 18, 39 and 43 m [31].

As an example, curves in Fig. 10 show the cdf of CMRR in the 1-30 MHz band, at 4 ends of the harness: SPDB and IBUs 4, 11 and 14. It clearly appears that CMRR strongly depends on the configuration of the harness in the vicinity of the DM injection port.

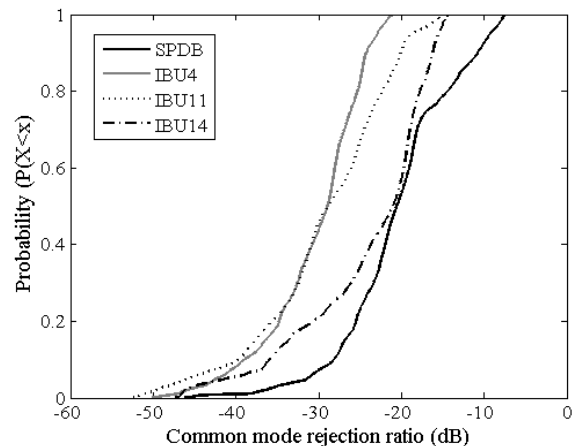

Figure 10. Cumulative distribution function of common mode rejection ratio near 4 ends of the link: SPDB and IBUs 4, 11 and 14. [31]

Similarly, disturbing noise appearing on the receiving modem and due to devices connected to the other wires, also depends on CMRR. Therefore, a statistical analysis of the DM to CM coupling factor considering the entire PLC frequency band and all injection ports must be carried out, results being then introduced in the channel model to determine the SNR at the receiving ports.

Lastly, it is interesting to determine the throughput of each PLC link, defined as the rate that can be reached for a prescribed maximum value of the bit error rate (BER). The throughput is often known as BER Threshold Constant [33].

It is worth mentioning that, for the CLS configuration and using the PHY layer described in [31], the predicted throughput for a target BER of  $10^{-3}$  reaches, for the worst link, 78 Mbits/s, this value being experimentally confirmed. The next step for assessing PLC in A/C and S/C is to take into account operational/safety aspects and compliance with real time constraints, as latency.

#### IV. Conclusion

This paper summarizes the recent achievements in the characterization and modeling of the power line communication channels in vehicle, spacecraft and aircraft. The typical topological features of the power networks used for these transportation systems are discussed, along with the most suitable modeling approaches that have been proposed in the state-of-the-art literature. Physical-based and transmission line models or surrogate representations are the key resources that have been successfully applied in a number of real examples to accurately represent the functional behavior of the communication channel.

It was outlined that networks in car and A/C have a similar tree-shaped architecture, even if the typical length of a link in a car is between 3 and 6 m, as opposed to an aircraft where this length may reach 40-50 m. Despite this difference, insertion loss may be rather important in cars especially if the path between the modems passes through the battery which likely behaves as a short circuit. In this case, the median value of insertion loss in the 1-30 MHz band is about 40 dB, instead of 20 dB in the other cases. In A/C, a strong attenuation occurs at each multiplying connector and consequently, IG has the same order of magnitude as in cars. In both cases, the numerous branches give rise to frequency selective channels. The most critical point for PLC implementation is related to the EMC with the environment. Indeed, standards on radiated and conducted emissions are much more restrictive in the avionics sector. If CM transmission, i.e. between a power line and the chassis, may be reasonable in a car, DM transmission must be used in A/C to take profit from the CM to DM rejection.

In S/C, power-supply networks present a star topology, avoiding multipath propagation scenarios. Channel characteristics are thus optimal for high bit rate data transmission, especially given that the power buses have a twisted-wire structure supporting DM signaling. As for A/C, disturbing currents and radiated fields must comply with EMC standards. The DM/CM rejection factor plays an important role on the communication performances, taking into account not only the power cable but also the electrical structure of the loads.

This tutorial paper thus provides a unified picture of the PLC modeling for transportation systems and offers a solid ground for current and future research activities needed to assess the robustness of PLC technology accounting for both operational and safety aspects.

#### References

- [1] F. Nouvel, P. Tanguy, S. Pillement, and H. M. Pham, "Experiments of in-vehicle power line communications", chapter 14 in the book "Advances in vehicular networking technologies", M. Almeida, Ed., Intech Pub., pp. 255–278, 2011.
- [2] J. Wolf, "Power Line Communication (PLC) in Space -Current Status and Outlook", in *Proc. of ESA Workshop on Aerospace EMC*, Venice, Italy, pp. 1–6, 2012.
- [3] H. C. Ferreira, L. Lampe, J. Newbury, and T. G. Swart (Eds.), "Power Line Communications: Theory and Applications for Narrowband and Broadband Communications over Power Lines," Wiley, 2010.
- [4] L. M. Correia (Ed.), "Mobile broadband multimedia networks: techniques, models and tools for 4G," Elsevier Academic Press, 2006.
- [5] S. Salous, "Radio propagation measurements and channel modeling," Wiley Ed. 2013.
- [6] EUROCAE-ED-14G, RTCA/DO-160G, "Environmental conditions and test procedures for airborne equipment," 2011.
- [7] Dept. of Defense, "Requirements for the control of electromagnetic interference characteristics of subsystems and equipment," MIL-STD-461E, Aug.20, 1999.
- [8] CISPR 25, "Vehicles, boats and internal combustion engines - Radio disturbance characteristics - Limits and methods of measurement for the protection of on-board receivers", Ed. 3.0, 2008.
- [9] A. Vukicevic, M. Rubinstein, F. Rachidi, and J. L. Bermudez, "On the mechanisms of differential-mode to common-mode conversion in the broadband over power line frequency band," in *Proc. 17<sup>th</sup> Int. Zurich Symp.*, pp. 658-661, 2006.
- [10] A. Sugiura, Y. Kami, "Generation and propagation of common-mode currents in a balanced two-conductor line," *IEEE Trans. Electromagn. Compat.*, vol. 54, no.2, pp. 466-473, 2012.
- [11] ITU-T, "Transmission aspects of unbalance about earth," Recommendation G.117, Geneva, Switzerland, 1989.
- [12] www.statista.com/statistics, 2015
- [13] N. Navet, Y-Q. Song, "The Automotive Embedded Systems Handbook", Industrial Information Technology series, CRC Press, 2008.
- [14] M. Lienard, M. Carrion, V. Degardin, and P. Degauque, "Modeling and analysis of in-vehicle power line communication channels," *IEEE Trans. on Vehicular Technology*, vol. 57, no. 2, pp. 670–679, Mar. 2008.
- [15] I.S. Stievano, F. Canavero, W. Garcia Valverde, L. Guerrieri and P. Bisaglia, "Multipath modeling of automotive power line communication channels," *IEEE Trans. Industrial Informatics*, vol. 10, no. 2, pp. 1381–1391, 2014.
- [16] A.B. Vallejo-Mora, J.J. Sánchez-Martínez, F.J. Cañete, J.A. Cortés and L. Díez, "Characterization and evaluation of in-vehicle power line channels," in *Proc. of IEEE Global Telecomm. Conf. (GLOBECOM)*, Miami, USA, pp. 1–5, 2010.
- [17] S. Barmada, M. Raugi, R. Rizzo, and M. Tucci, "Channel evaluation for power line communication in plug - in electric vehicles", *IET Electrical Systems in Transportation*, vol. 2, no. 4, pp. 195–201, 2012.
- [18] L. Guerrieri, P. Bisaglia, I.S. Stievano, and F.G. Canavero, "Statistical Assessment of Automotive PLC Multipath Channel Models", in *Proc. of IEEE Int. Symp. on Power Line Commun. and its Applic. (ISPLC)*, Glasgow, Scotland, pp. 47–51, 2014.
- [19] M. Mohammadi, L. Lampe, M. Lok, S. Mirabbasi, M. Mirvakili, R. Rosales, and P. van Veen, "Measurement study and transmission for in-vehicle power line communication," in *Proc. IEEE Int.Symp. on Power Line Commun and its applic. (ISPLC)*, pp.73-78, March 2009.
- [20] V. Degardin, F. Rouissi, M. Lienard, P. Degauque and A. Zeddou, "Comparison of in-house and in-vehicle noise characteristics in PLC systems," in *Proc. URSI General Assembly*, 2008.
- [21] V. Degardin, M. Lienard, P. Degauque, E. Simon, and P. Laly, "Impulsive noise characterization of in-vehicle power line," *IEEE Trans. Electromagn. Compat.*, vol. 50, no. 4, pp. 861-868, 2008



- [22] J. A. Cortes, M. Cerda, L. Diez, and F. J. Cañete, "Analysis of the periodic noise on in-vehicle broadband power line channels," in *Proc. Int. Symp. Power Line Commun. and its Applic. (ISPLC)*, Beijing, China, pp. 334–339, 2012.
- [23] F. Grassi and S. A. Pignari, "Immunity to conducted noise of data transmission along dc power lines involving twisted-wire pairs above ground," *IEEE Trans. Electromagn. Compat.*, vol. 55, no. 1, pp. 195–207, Feb. 2013.
- [24] S. Galli, "A simple two-tap statistical model for the power line channel," in *Proc. Int. Symp. Power Line Commun. and its Applic. (ISPLC)*, Rio de Janeiro, pp. 242–248, 2010.
- [25] M. Zimmermann and K. Dostert, "A multipath model for the power line channel," *IEEE Trans. Commun.*, vol. 50, no. 4, pp. 553–559, 2002.
- [26] S. Galli, "Novel approach to the statistical modeling of wireline channels," *IEEE Trans. on Communications*, vol. 59, no. 5, pp. 1332–1345, 2011.
- [27] C. R. Paul, "Analysis of multiconductor transmission line," 2nd edition, Wiley-IEEE Press, 2007.
- [28] C. Buccella, V. De Santis, and M. Feliziani, "Channel characterization of power line communications over in-vehicle wire harness", in *Proc. of 10th Int. Symp on Electromagn. Compat. (EMC Europe)*, York, U.K., pp. 204–207, 2011.
- [29] A. M. Tonello, F. Versolatto, B. Bejar and S. Zazo, "A fitting algorithm for random modeling the PLC channel", *IEEE Trans. on Power Delivery*, vol. 27, no. 3, pp. 1477 – 1484, 2012.
- [30] F. Grassi, S. A. Pignari, and J. Wolf, "Channel characterization and EMC assessment of a PLC system for spacecraft dc differential power buses," *IEEE Trans. on Electromagn. Compat.*, vol. 53, no. 3, pp. 664–675, Aug. 2011.
- [31] V. Degardin, P. Laly, M. Lienard, and P. Degauque, "Investigation on power line communication in aircrafts", *IET Communications*, vol. 8, no. 10, pp. 1868–1874, 2014.
- [32] V. Degardin, I. Junqua, M. Lienard, P. Degauque, and S. Bertuol, "Theoretical approach to the feasibility of power line communication in aircrafts", *IEEE Trans. on Vehicular Technology*, vol. 63, no. 2, pp. 1362–1366, 2013.
- [33] E. Guerrini, G. Dell'Amico, P. Bisaglia, and L. Guerrieri, "Bit-loading algorithms and SNR estimate for HomePlug AV", in *Proc. of the IEEE ISPLC Conf.*, Pisa, Italy, pp. 419–424, 2007.

## Author Information

**Pierre Degauque** (pierre.degauque@univ-lille1.fr) received his Engineering degree from the Institut Supérieur d'Electronique du Nord, Lille, in 1967 and his Ph.D. degree from the Université of Lille, France, in 1970. He is currently a Professor with the TELEcommunications, Interferences et Compatibilité Electromagnétique (TELICE) Group, Institut d'Electronique de Microélectronique et de Nanotechnologie, Université Lille 1. He has been working in the field of electromagnetic wave propagation and radiation from various antenna configurations. He was involved in research on radiation of antennas in absorbing media for geophysical applications. His main research interests include radio propagation in confined areas, power line communications, and electromagnetic compatibility. He was the Vice Chairman of the International Union of Radio Science Commission E, Electromagnetic Noise and Interference from 1999 to 2002 and the Chairman from 2002 to 2005.

**Igor S. Stievano** (igor.stievano@polito.it) received the master's degree and the PhD degree in electronic engineering from the

Politecnico di Torino, Torino, Italy, in 1996 and in 2001, respectively. Currently he is an Associate Professor of Circuit Theory with the Department of Electronics and Telecommunications, Politecnico di Torino. His research interests are in the field of Electromagnetic Compatibility and Signal Integrity, where he works on the modeling and characterization of linear and nonlinear circuit elements. His recent activities include the behavioral modeling of digital ICs, transmission lines and PLC channels, the modeling and simulation of switching converters and the development of stochastic methods for the statistical simulation of circuits and systems with the inclusion of the effects of device or manufacturing uncertainties.

**Sergio A. Pignari** (sergio.pignari@polimi.it) received the Laurea and Ph.D. degrees in electronic engineering from the Politecnico di Torino, Turin, Italy, in 1988 and 1993, respectively. He is currently a Full Professor with the Department of Electronics, Information, and Bioengineering at Politecnico di Milano, Italy. His current research interests include characterization of interference effects, distributed-parameter circuit modeling, statistical techniques for EMC, and experimental procedures and setups for EMC testing. Dr. Pignari was the recipient of the IEEE EMC Society 2004 Transactions Prize Paper Award. He is currently an Associate Editor of the IEEE Transactions on EMC and the IEEE EMC Society Chapter Coordinator.

**Virginie Dégardin** (virginie.degardin@univ-lille1.fr) received the Engineer degree from the École Universitaire d'Ingénieurs de Lille, France, in 2000 and the Ph.D. degree from the Université Lille 1, France, in 2002. Since 2003, she has been with the TELEcommunications, Interferences et Compatibilité Electromagnétique (TELICE) Group, Institut d'Electronique de Microélectronique et de Nanotechnologie, Université Lille 1, where she is currently a Professor. Her current research interests include both the theoretical and experimental characteristics of power-line channels and the optimization and performance of multicarrier modulation, with applications to power-line communications and avionic and road transportation communications.

**Flavio G. Canavero** (flavio.canavero@polito.it) received the degree in electronic engineering from the Politecnico di Torino, Torino, Italy, in 1977, and the PhD degree from the Georgia Institute of Technology, Atlanta, USA, in 1986. He is currently a Professor of circuit theory and electromagnetic compatibility with the Department of Electronics and Telecommunications at Politecnico di Torino, where he serves also as the Director of the Doctoral School. His research interests are in the field of signal integrity and electromagnetic compatibility. He is the author or co-author of approximately 200 papers published in international journals and conference proceedings. He is past

Editor-in-Chief of IEEE Transactions on Electromagnetic Compatibility, and past Chair of URSI Commission E.

*Flavia Grassi* (flavia.grassi@polimi.it) received the Laurea and Ph.D. degrees in electrical engineering from the Politecnico di Milano, Italy, in 2002 and 2006, respectively, where she is currently an Assistant Professor with the Department of Electronics, Information and Bioengineering. From 2008 to 2009, she was with the European Space Agency (ESA), The Netherlands. Her research interests are focused on the characterization of measurement setups for electromagnetic compatibility testing (aerospace and automotive sectors), and applications of the powerline communications (PLC) technology on ac and dc lines.

*Francisco J. Cañete* (francis@ic.uma.es) received the M.S. and Ph.D. degrees in Telecommunication Engineering in 1996 and 2004, respectively, from the Universidad de Málaga (Spain). In 1996, he worked at INITEC in the design of power plants. In 1997, he worked for Alcatel Spain in the design of wireless local loop systems. In 1998, he joined the Ingeniería de Comunicaciones Department at Universidad de Málaga. At present, he is an associate professor and head of department. From 2000 to 2001, he also collaborated with the Nokia System Competence Team in the design of radio access networks. His current research activity is focused on signal processing for digital communications with interest in channel modelling and transmission techniques for wireless systems, underwater acoustic communications and Power-Line Communications.